

2000 SERIES PUENTE DE LUCES / LIGHTBAR

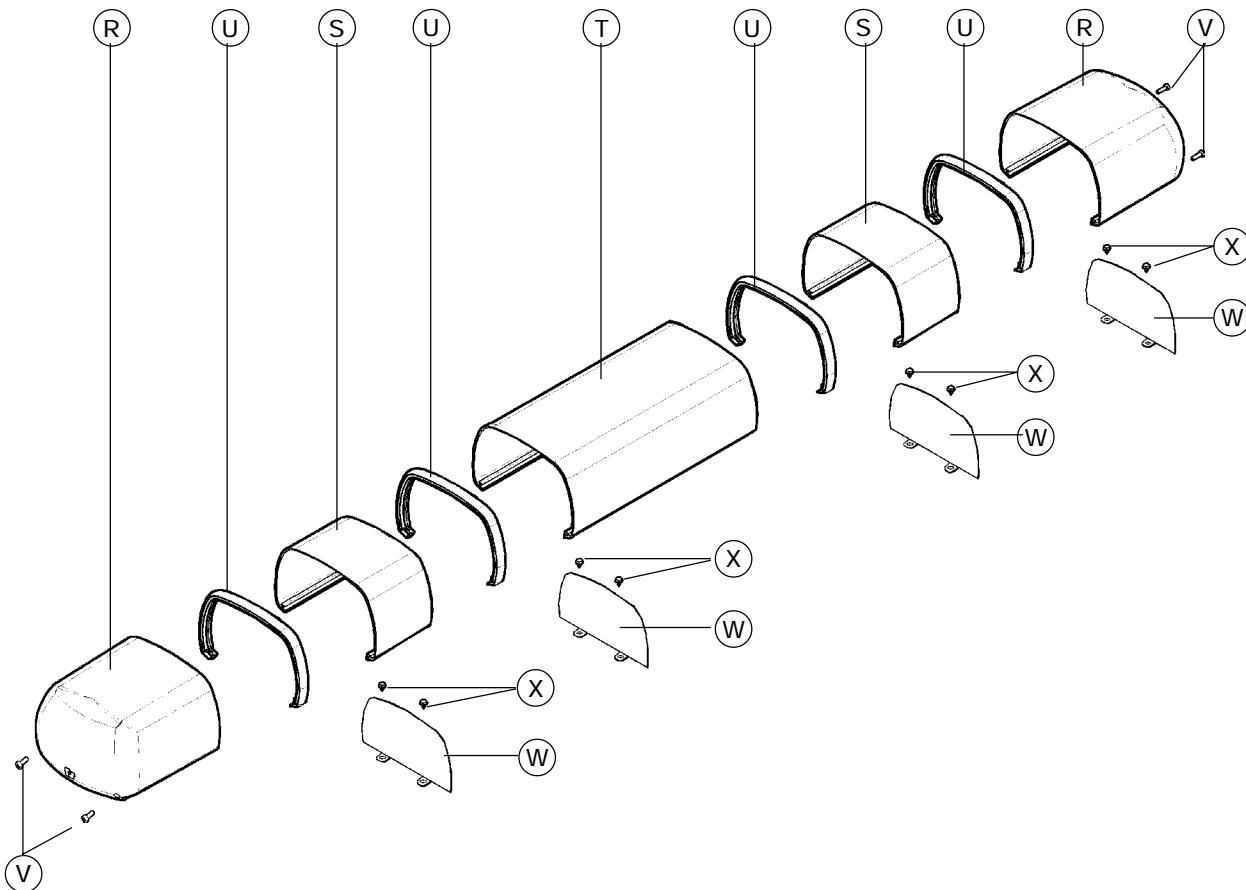

Item N.	Descripción / Description	Ref.	Cant. /Qty.
A	Lámpara halógena 12V 55W H1 / H1 55W 12V halogen lamp	9012050REC	2
	Lámpara halógena 24V 70W H1 / H1 70W 24V halogen lamp	9012021	2
B	Conjunto parábola + base rotativo / rotator base + parabola assembly	8299270REC	2
C	Clip fijación lámpara / lamp fixation clip	9032077	2
D	Correa rotativo D74,5x2,5x2 negra / black D74,5x2,5x2 rotator belt	9151265REC	2
E	Anillo elástico D6 DIN471 / DIN471 6 diameter elastic ring	9028046	2
F	Piñón reductor 1 LR-025 / LR-025 1 reductor pinion	9151078	2
G	Rueda motor rotativo eco / Eco rotator motor wheel	9151221	2
H	Motor 12V con sinfín / conveyor-belt + 12V motor	8299267REC	2
	Motor 24V con sinfín / conveyor-belt + 24V motor	8299268REC	2
I	Conjunto rotativo 12V / 12V rotator assembly	8236083REC	2
	Conjunto rotativo 24V / 24V rotator assembly	8236085REC	2
J	Bombilla bayoneta 12V 15W / 15W 12V bayonet bulb	9011014	2
	Bombilla bayoneta 24V 15W / 15W 24V bayonet bulb	9011021	2
K	Lámpara halógena 12V 55W H3 / H3 55W 12V halogen lamp	9012003	2
	Lámpara halógena 24V 70W H3 / H3 70W 24V halogen lamp	9012002	2
L	Bombilla bayoneta 12V 21W / 21W 12V bayonet bulb	9011022	4
	Bombilla bayoneta 24V 21W / 21W 24V bayonet bulb	9011029	4
M	Bombilla bayoneta 12V 10W / 10W 12V bayonet bulb	9011030	2
	Bombilla bayoneta 24V 10W / 10W 24V bayonet bulb	9011032	2
N	Conjunto Piloto Posterior Izquierdo / Left Rear Light Assembly	8299350REC	1
O	Conjunto Piloto Posterior Derecho / Right Rear Light Assembly	8299349REC	1
P	Módulo LED, SMLED-KS-HD, ámbar, 12V / LED module, SMLED-KS-HD, amber, 12V	8235610HD	8
	Módulo LED, SMLED-KS-HD, ámbar, 24V / LED module, SMLED-KS-HD, amber, 24V	8235612HD	8
Q	Módulo LED, SMLED-KS, ámbar, 12V / LED module, SMLED-KS, amber, 12V	8235610	8
	Módulo LED, SMLED-KS, ámbar, 24V / LED module, SMLED-KS, amber, 24V	8235612	8
R	Carena lateral ambar / amber lateral dome	9151333-01	2
	Carena lateral azul / blue lateral dome	9151333-04	2
	Carena lateral roja / red lateral dome	9151333-05	2
S	Carena central cristal / clear middle dome	9151332-02	L.97 mm.
	Carena central cristal / clear middle dome	9151332-02	L. 147 mm.
T	Carena central ambar / amber middle dome	9151332-01	1
	L. 234-334-434-534-634-734-834-934-1034-1134-1434 mm.		
	Carena central azul / blue middle dome	9151332-06	1
	L. 234-334-434-534-634-734-834-934-1034-1134-1434 mm.		
	Carena central opal / opal middle dome	9151332-03	1
	L. 234-334-434-534-634-734-834-934-1034-1134-1434 mm.		
U	Carena central cristal / clear middle dome	9151332-02	1
	L. 234-334-434-534-634-734-834-934-1034-1134-1434 mm.		
U	Separador carena / dome separator	9151337	4
V	Tornillo / screw M04X16 DIN7985 AL PH INOX	9027779	4
W	Separador rotativos / Rotators separator	8152339	4
X	Tornillo cabeza hexagonal / hexagon head screw 4,9x9,5 DIN7670	9027238	8

Nota: Recambios. Cantidad máxima necesaria. / Note: Spare Parts. Necessary maximum quantity.

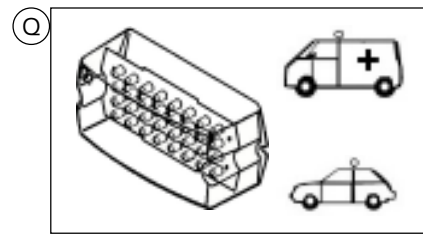
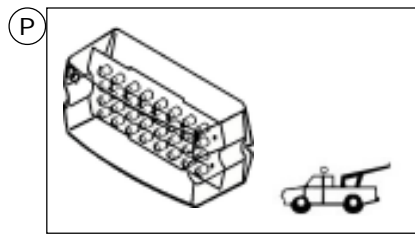
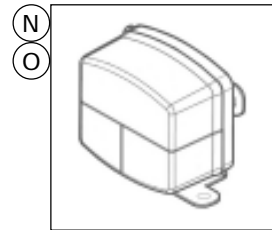
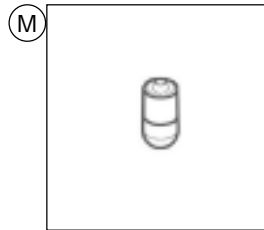
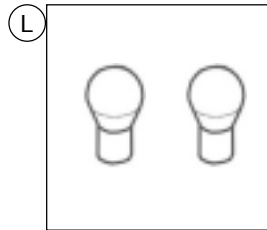
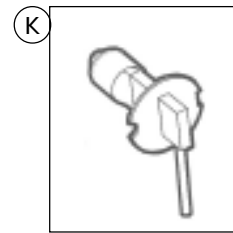
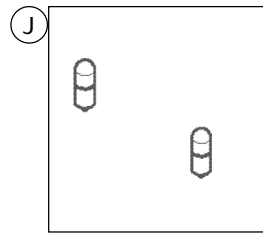
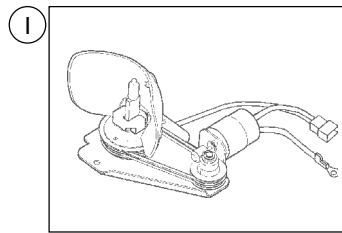
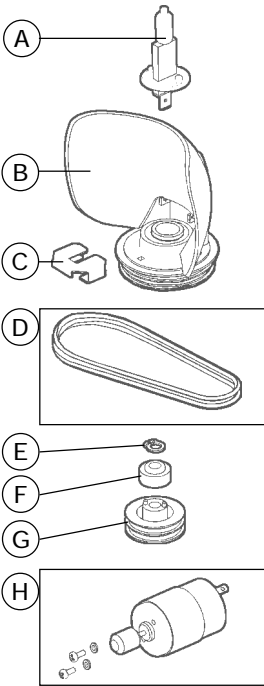

Empresa certificada ISO / ISO certified Company

FEDERAL SIGNAL VAMA, S.A

Dr. Ferrán, 7 (08339) VILASSAR DE DALI,
BARCELONA, SPAIN

Tel. (00) 93 741 79 42 (Spain)

Tel. (34) 93 741 79 41 (Int.)

Fax (34) 93 753 03 62

email: service@vama.es

Web : www.fedsig.vama.es

Delegación - Madrid

Avda. Baviera, 13

(28028) MADRID

Tel. (34) 91 355 22 00

Fax (34) 91 355 35 61

email: servicemad@vama.es