



MICROLIGHT 2G PLUS

SISTEMA ESTROBOSCÓPICO EMPOTRABLE

BUILT-IN STROBE SYSTEM

RECAMBIOS / SPARE PARTS

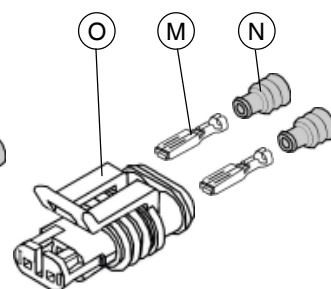
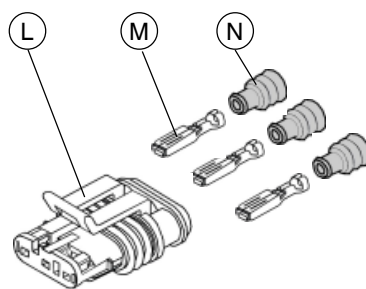
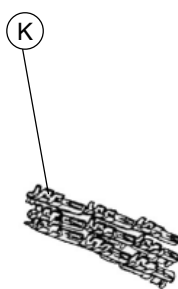
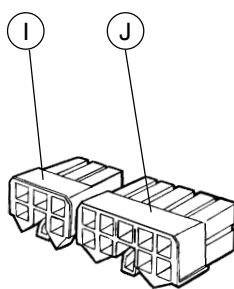
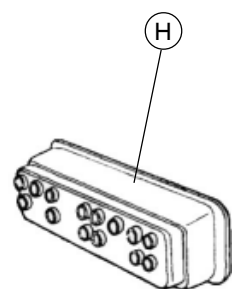
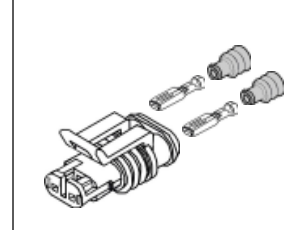
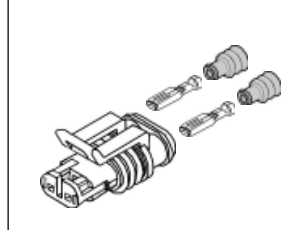
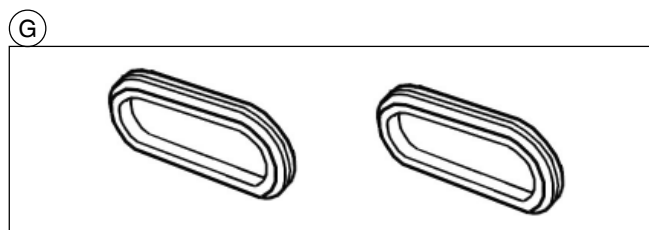
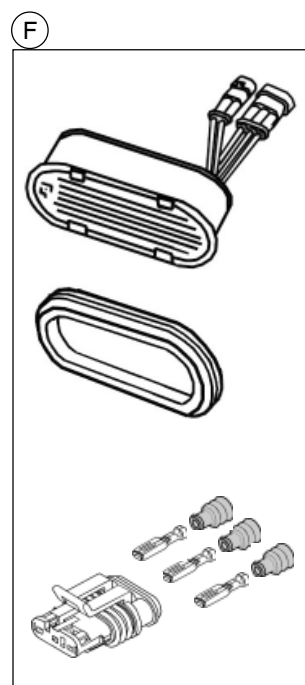
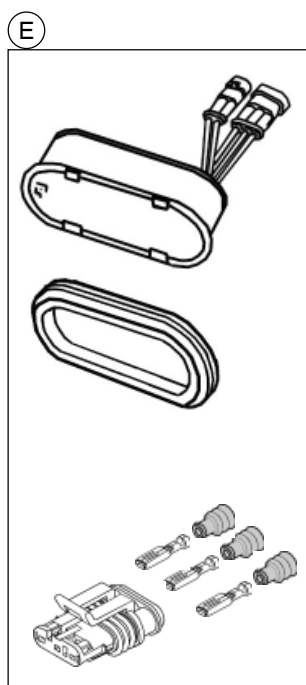
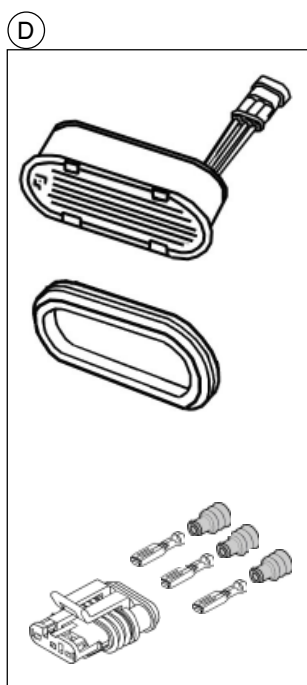
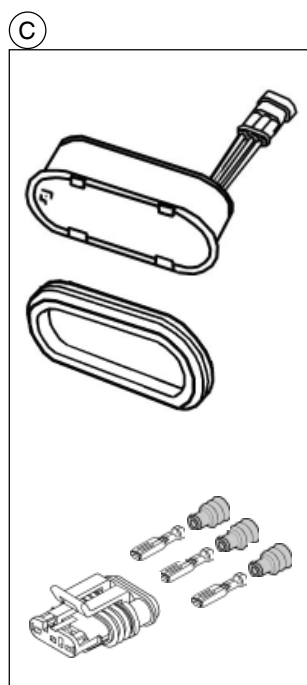
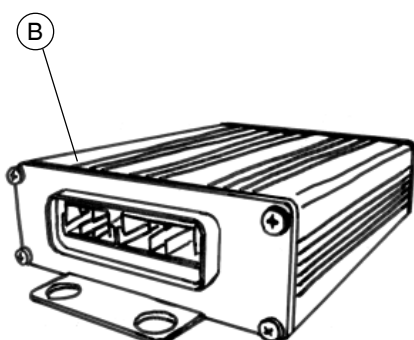
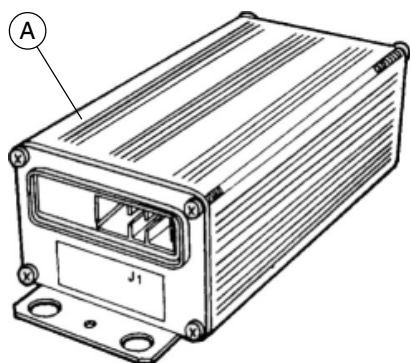

Item N.	Descripción / Description	Ref.	Cant./Qty.
A	FA-ML2A fuente alimentación, destellos dobles alternados, 12/24V <i>FA-ML2A power supply, alternated double flashes, 12/24V</i>	2004091	1
	FA-ML2S fuente alimentación, destellos dobles simultaneos, 12/24V <i>FA-ML2S power supply, simultaneos double flashes, 12/24V</i>	2004093	1
B	FA-ML4 fuente alimentación, destellos dobles alternados, 12/24V <i>FA-ML4 power supply, alternated double flashes, 12/24V</i>	2004092	1
C	MICROLIGHT 2G, luz estroboscópica, lente lisa, ámbar <i>MICROLIGHT 2G, strobe light, smooth lens, amber</i>	2005366	1
	MICROLIGHT 2G, luz estroboscópica, lente lisa, azul, norma alemana K <i>MICROLIGHT 2G, strobe light, smooth lens, blue, German K Standard</i>	2005364	1
	MICROLIGHT 2G, luz estroboscópica, lente lisa, roja <i>MICROLIGHT 2G, strobe light, smooth lens, red</i>	2005368	1
	MICROLIGHT 2G, luz estroboscópica, lente lisa, cristal <i>MICROLIGHT 2G, strobe light, smooth lens, clear</i>	2005370	1
D	MICROLIGHT 2G, luz estroboscópica, lente Fresnel V15, ámbar <i>MICROLIGHT 2G, strobe light, Fresnel V15 lens, amber</i>	2005367	1
	MICROLIGHT 2G, luz estroboscópica, lente Fresnel V15, azul, norma alemana K <i>MICROLIGHT 2G, strobe light, Fresnel V15 lens, blue, German K Standard</i>	2005365	1
	MICROLIGHT 2G, luz estroboscópica, lente Fresnel V15, rojo <i>MICROLIGHT 2G, strobe light, Fresnel V15 lens, red</i>	2005369	1
	MICROLIGHT 2G, luz estroboscópica, lente Fresnel V15, cristal <i>MICROLIGHT 2G, strobe light, Fresnel V15 lens, clear</i>	2005371	1
E	MICROLIGHT 2G, luz estroboscópica, lente lisa, azul, luz de crucero <i>MICROLIGHT 2G, strobe light, smooth lens, blue, cruise light</i>	2005372	1
F	MICROLIGHT 2G, luz estroboscópica, lente Fresnel V15, azul, luz de crucero <i>MICROLIGHT 2G, strobe light, Fresnel V15 lens, blue, cruise light</i>	2005373	1
G	Kit de (2) juntas para Microlight™ (montaje empotrado) <i>(2) Joints kit for Microlight™ (flush mount)</i>	2010231	1
H	Funda conector MIC5 + MIC9 <i>MIC5 + MIC9 connector cover</i>	9151208	1
J	Caja Receptora MIC 5V 142257-1 (sólo para FA-ML4) <i>142257-1 5 ways MIC receiver box (only for FA-ML4)</i>	9018380	1
J	Caja Receptora MIC 9V 142259-1 <i>142259-1 9 ways MIC receiver box</i>	9018383	1
K	Terminal MIC-H AMP 142185-1 banda (16 terminales sólo para FA-ML4) <i>Strip 142185-1 AMP MIC-H terminal (16 terminals only for FA-ML4)</i>	9018381	11/16
L	Caja Multilok 3V 282087-1 Mach <i>Mach 282087-1 3 ways Multilok box</i>	9018627	1
M	Terminal Receptor Multilok 282110-1 <i>282110-1 Multilok receiver terminal</i>	9018623	1
N	Junta de goma AMP281934-3 roja <i>Red AMP281934-3 rubber joint</i>	9018624	1
O	Caja Multilok 2V 282080-1 Mach <i>Mach 282080-1 2 ways Multilok box</i>	9018622	1



Empresa certificada ISO / ISO certified Company

FEDERAL SIGNAL VAMA, S.A

Dr. Ferrán, 7 (08339) VILASSAR DE DALT,
BARCELONA, SPAIN

Tel. (00) 93 741 79 42 (Spain)

Tel. (34) 93 741 79 41 (Int.)

Fax (34) 93 702 59 35

email: service@vama.es

Web : www.fedsig.vama.es

Delegación - Madrid

Avda. Baviera, 13

(28028) MADRID

Tel. (34) 91 355 22 00

Fax (34) 91 355 35 61

email: servicemad@vama.es